

Thank you for choosing a high-quality DAYTONA VELONA60 display instrument. With proper installation and connection, you will have long-lasting pleasure with this high-quality product when used as intended.

When installing, please make sure that the speed indicator is located in the immediate view of the driver. Attach the housing securely to the enclosed V-Bracket or mount with an at least equivalent holder permanently to the bike. Do not use longer screws to connect the holder to the housing, as longer screws can damage the instrument's internal components. Attach the instrument in a way that no part obstructs or restricts the steering. Route the wiring in such a way, that the full steering angle works in both directions without hindrance and no cables are pinched or under tension when the steering moves. Protect the cabling, also in the long term, against chafing and damage during the constantly occurring steering movements.

Read this assembly and installation manual before installing and operating the display instrument. Proper installation and electric connection requires technical expertise, special tools and skilled craftsmanship. If you are unsure about the installation, have it done, for your own safety, by a trained mechanic.

CAUTION

- Read all instructions before use.
- Needs to purchase the optional speed sensor if the vehicle does NOT come with an electrical speed sensor. Or use a converter (sold separately) that turns mechanical movement into electrical pulse, if the vehicle comes with a mechanical speedometer cable. (See the optional parts section in this manual.)
- Designed for a 12V system vehicle. VELONA gauges do NOT work with a 6V system or a battery-less system.
- VELONA gauges might not work normally when used together with other device that emits much noise.
- Use VELONA gauges for the intended purpose of use.
- VELONA gauges is for universal use, so it needs wiring for installation. Do the wiring referring to the vehicle owner's manual. (If you are not sure about installation, consult an experienced dealer.)
- Do NOT disassemble VELONA gauges. It may be damaged and water may come in.
- Do NOT leave VELONA gauges in high heat when not used for a long time.
- Do NOT hit, drop or give a shock on VELONA gauges. It may be damaged.
- Avoid contact with gasoline, brake fluid or other chemicals. It may be damaged.
- After installation, check to see if all the parts are correctly installed, and to see if all the screws are properly tightened.
- Inspect all installed parts after 100km driving. Periodical inspection is required every 500km(300mile). If anything unusual found while driving, pull over at a safe place to check.

PRODUCT FEATURES

- Stepping motor-driven
- KM/H or MPH selectable
- Odometer (NOT Resettable) : 0.0-99,999.9km (mile)
- Dual Trip Meter (Resettable) : 0.0-99,999.9km (mile)
- Ability to connect to OEM speed sensor, if the vehicle is equipped with an electrical speed sensor.
- Voltmeter : 0.0-18.0V
- Maximum speed memory and recall
- Indicators (turn signal[L/R], high beam, neutral, warning)
- Power DC9-16V (regular 12V)

COMPONENTS

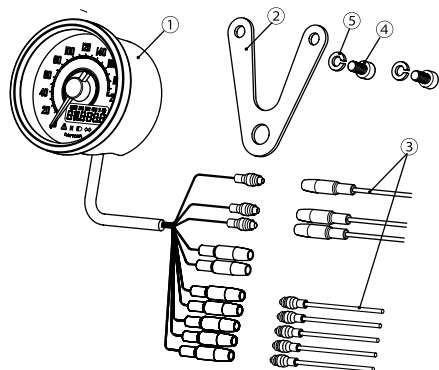

NO.	DESCRIPTION	REMARKS	Q'TY
①	Gauge Unit		1
②	V-Bracket		1
③	Extension Wire Set	8 pcs	1set
④	Cap Screw	M5x10	2
⑤	Spring Washer	M5	2

INSTALLATION

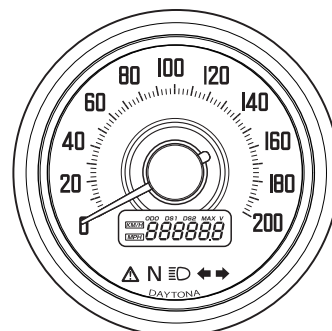

- ⚠ Wrong wiring may cause malfunction of the gauge. Make sure to have correct wiring.
- ⚠ Disconnect the ground wire from the negative post of vehicle's battery before installation.
- ⚠ The Red wire is to be connected to the wire that gives current when the main switch is turned on.
- ⚠ Connect SPEED pulse correctly.
- ⚠ Wrong wiring causes malfunction of the gauge.

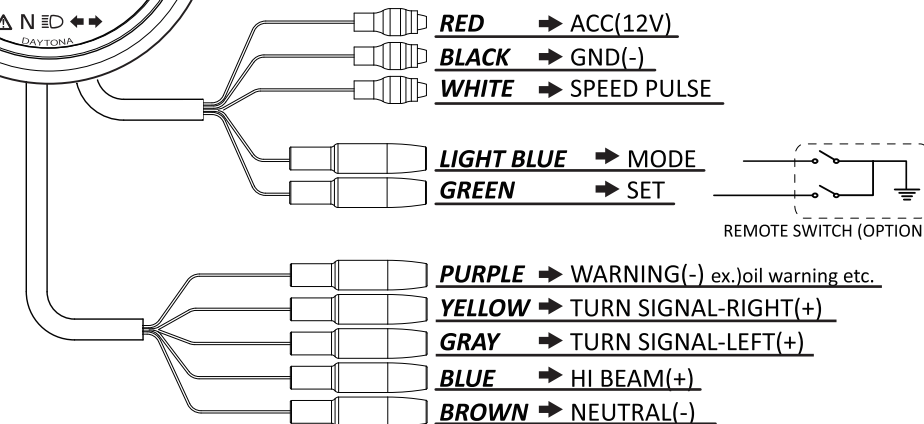

Indicator connected

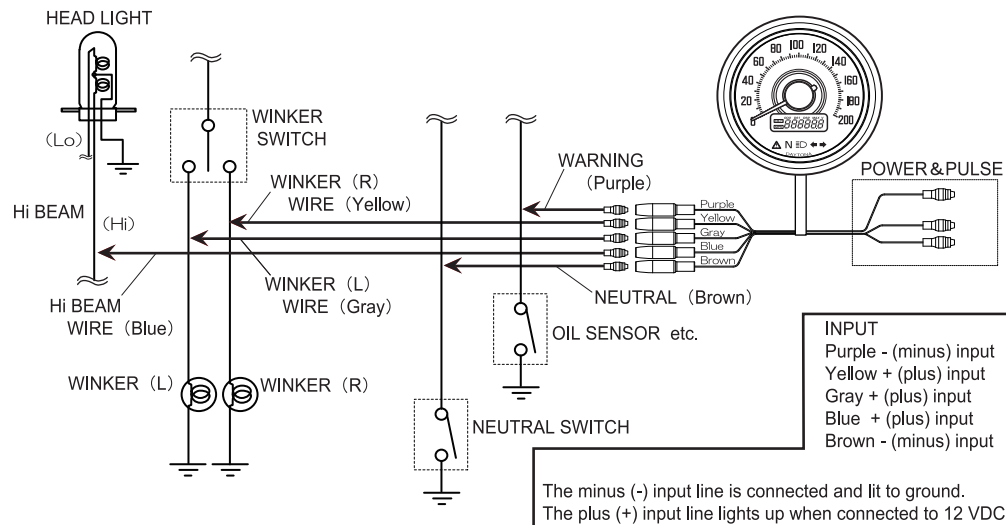

BUTTON OPERATION AND SETUP

⚠ Read all instructions before setting.
Especially for "speed calibration", initially decide which way you will do from 3 types.

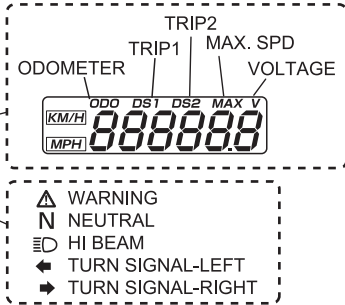
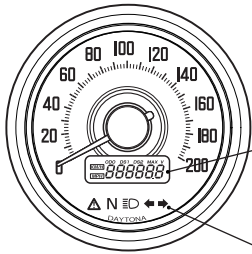
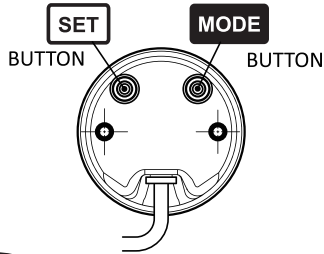

NORMAL MODE

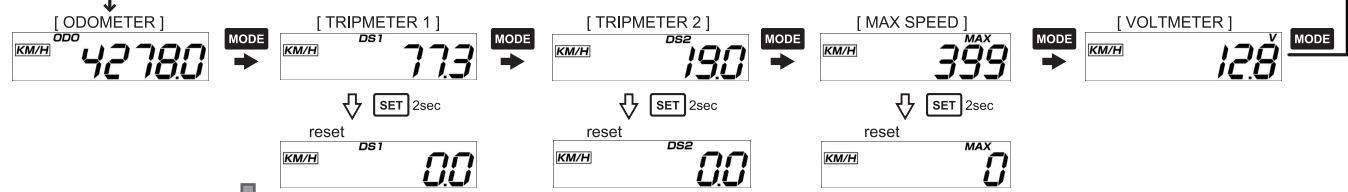

SETUP MODE

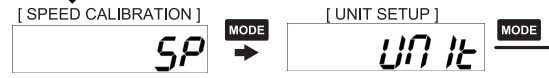

UNIT SETUP (KM/H or MPH)

At SETUP MODE, choose UNIT SETUP and hold down SET for 2 seconds.

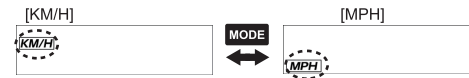

To switch between "KM/H" and "MPH", press MODE.

Hold down SET for 2 seconds. The display goes back to NORMAL MODE.

SPEED CALIBRATION

At SETUP MODE, choose SPEED CALIBRATION and hold down SET for 2 seconds. You can choose one way from 3 types of calibration.

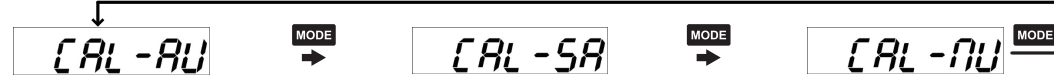

AUTO CALIBRATION MODE

When ready to drive, hold down SET for 2 seconds.



Press MODE.



Drive exactly one(1) kilometer/mile. (When driving, the display counts number of pulse obtained from sensor.)



After driving one(1) kilometer/mile, stop the vehicle and press MODE to finish the setting.



Hold down SET for 2 seconds. The display goes back to NORMAL MODE.



SPEED ADJUST MODE

When ready to drive, hold down SET for 2 seconds.



Start driving following another vehicle running at constant speed of 40km/h(MPH).



Press MODE in driving at actual speed 40km/h(MPH) to finish the setting.

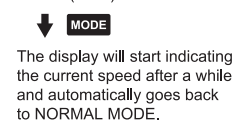

MANUAL MODE

Calculate the value of "pulse per km" by $A + B$

A pulses per revolution

Enter the AUTO CALIBRATION MODE, turn the wheel exactly 10 revolutions. The display shows the pulses per 10 revolutions. Divide this value by 10.

B tyre circumference (km)

Measure your tyre circumference in "cm" and divide by 100,000 to be "km".

$$A + B = \text{pulses per km}$$

Then enter MANUAL MODE and input this value as follows.

Hold down SET for 2 seconds.



To modify the number, press SET.



Press MODE to fix and go to the next digit setting.



Continue this operation until the last digit is input.

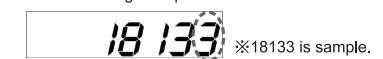

Hold down SET for 2 seconds.

The display goes back to NORMAL MODE.



OPTIONAL PARTS

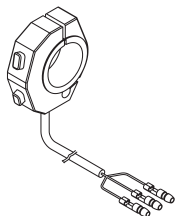

REMOTE SWITCH
<#87047(BLACK)>
<#87082(CHROME)>

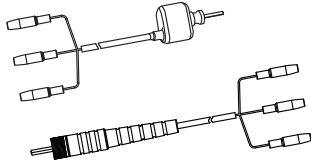

SPEED PULSE CONVERTER
DIA10 INSERT<#87755>
DIA15 INSERT<#87143>
DIA18 PLUG CONNECTION<#87041>
M12 THREAD FEMALE<#87429>
FOR BMW BOXER MODEL<#88457>

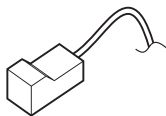

PROXIMITY SPEED SENSOR
<#87038>

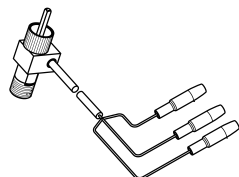

SPEED PULSE CONVERTER
TWIN SIGNAL<#87430>